

IO 信号分线盒



D267/A/B-4 D267/A/B-4P

D267/A/B-6 D267/A/B-6P

D267/A/B D267/A/B-P

D267/A/B-10 D267/A/B-10P

▶ 产品特点

- 可对应各种终端输入信号连接使用，配有 3P 信号输入接口，可接入 2 线制或 3 线制信号；
- 输入输出侧均为弹片式端子；
- 带有 LED 显示，输入输出状态一目了然；
- D267 系列产品主电路配有 1.5A 自恢复保险丝；
- D267A 系列各分支电路均配有 100mA 自恢复保险丝，D267B 系列各分支电路均配有 30mA 自恢复保险丝，支路间互不影响。



分类

总线模块

端子台

继电器模组

电缆线

传感器

适配端子

建议使用 E0308/E0310 针型端子，尺寸如图（金属部分长度 $\geq 8\text{mm}$ ）。

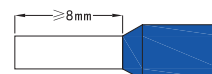

规格参数

	D267 系列	D267A 系列	D267B 系列
保护电流	主电路 1.5A	支路各 100mA	支路各 30mA
额定电压	DC24V		

选型指南

外形图

D267/A/B-4、D267/A/B-4P

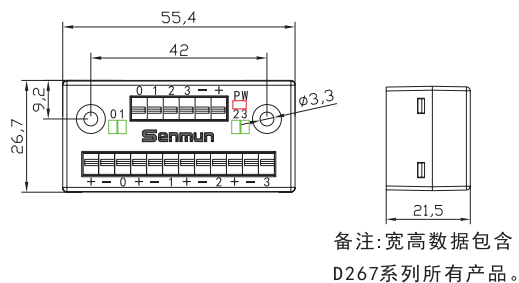

D267/A/B-6、D267/A/B-6P

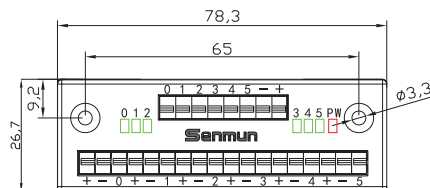

外形图

D267/A/B、D267/A/B-P

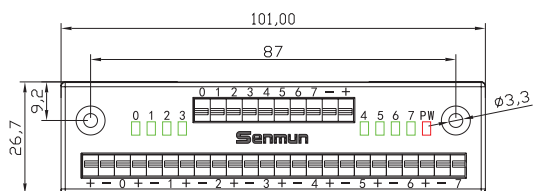

D267/A/B-10、D267/A/B-10P

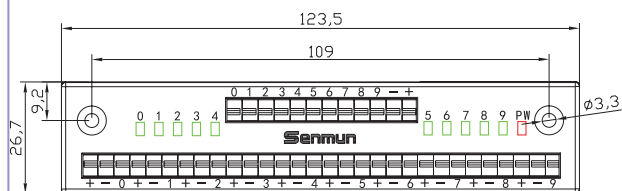

分类

总线模块

端子台

继电器模组

电缆线

传感器

配线图

D267-4

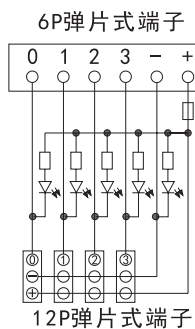

D267-4P

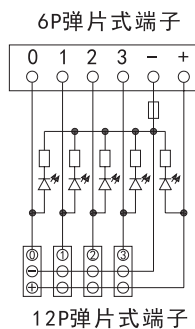

D267A-4/D267B-4

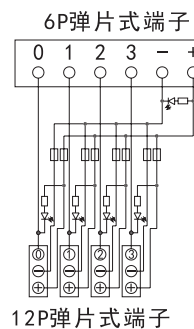

D267A-4P/D267B-4P

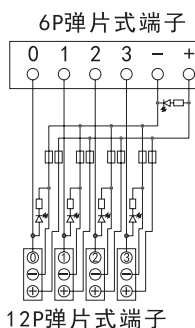

D267-6

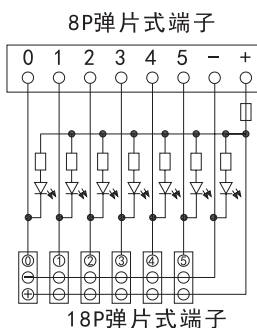

D267-6P

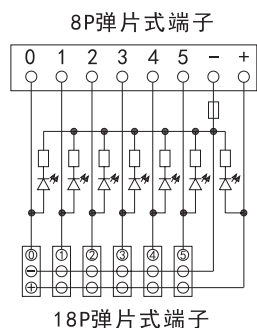

D267A-6/D267B-6

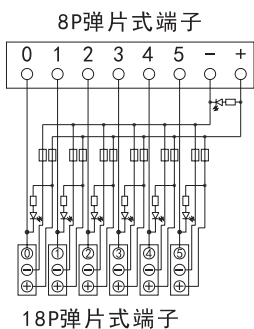

D267A-6P/D267B-6P

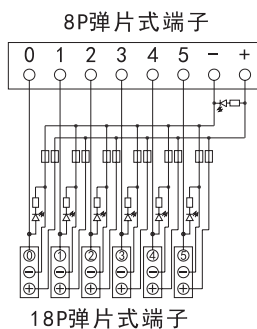

D267

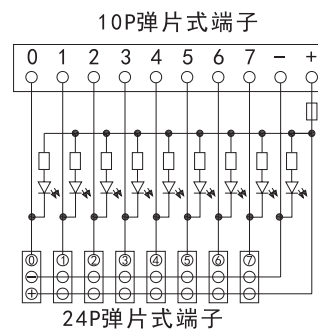

选型指南

配线图

D267-P

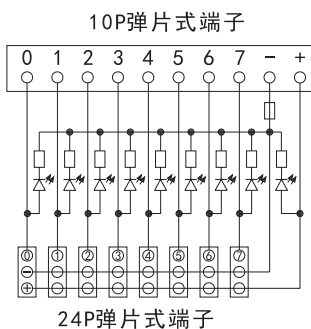

D267A/D267B

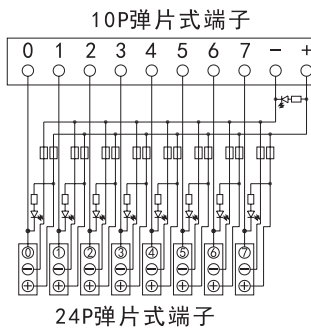

D267A-P/D267B-P

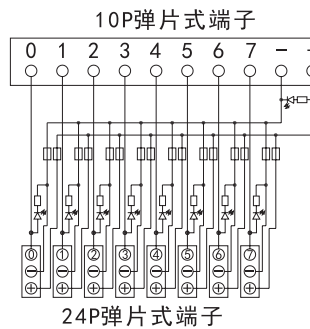

D267-10

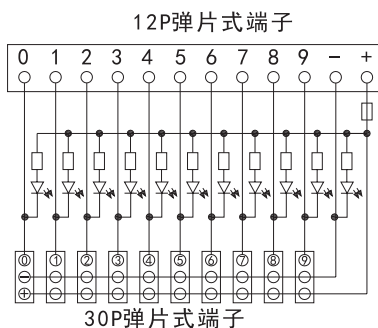

D267-10P

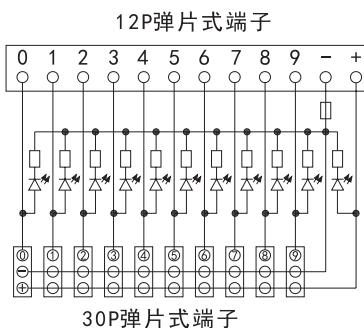

D267A-10/D267B-10

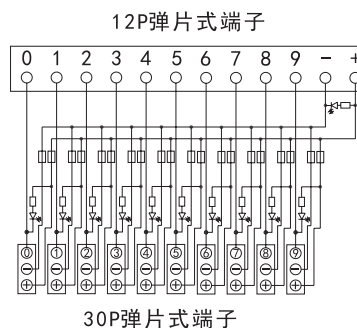

D267A-10P/D267B-10P

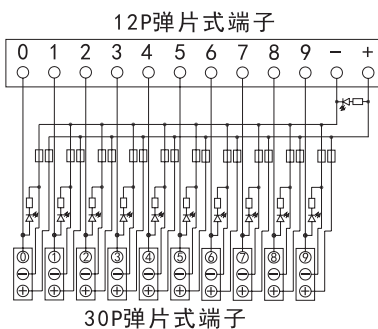

- 分类
- 总线模块
- 端子台
- 继电器模组
- 电缆线
- 传感器

选型指南